

Dolphin premium

24V 20A Charger

24V20A

TECHNICAL DATASHEET



Plug and Play Battery Charger

Protection:

- Output overload
- Excessive internal temperature
- Charging voltage too high
- Reverse battery polarity (fuse)

Input Voltage	115V / 230V (+/- 15%) Automatic Switchover
Frequency	50Hz / 60Hz (+/-10%)
Cos	0.9 typ
Efficiency	80% typ
Max. Current 115V/230V	7A / 3.5A
Input Fuse (5x20mm)	T10A 250V
Outputs	3 isolated outputs
Charging curves	4 programs, position selected by dip switch NEW - one of which is LiFeSO4 with integrated BMS
Charging curve	IUUo + weekly automatic equalisation
Weekly equalisation	Automatic
Voltage share	+/-2%
Ripple	< 1% pp (BW < 20MHz)
Output Fuse (auto. mini)	2 x F15A 32V
Display	Tricolour LED
Night/Silent Mode	Manual switch
Operating Temperature	-10°C to +50°C
Operating Humidity	10% to 90% (without condensation)
Ventilation	Forced fan cooling
Security	EN60335-2-29 (2002)
Housing	Powder coated aluminium
Mounting	2 screws 4mm
Input terminals	20A 230V, 4mm ² max WINSTA - WAGO 770.813 / G11-000
Battery terminal	40A 630V, 10mm ² max PHOENIX CONTACT PC6-16/4-G1F,16
CAN BUS	No
Dimensions	96 x 120 x 353 mm
Weight	1,90 Kg

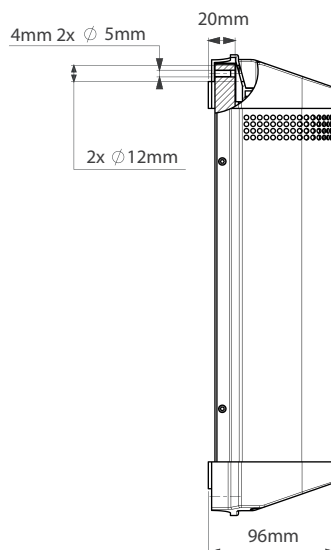
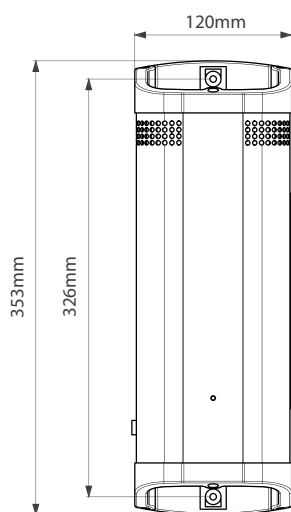

Part No. 399040 **Model** 24V 20A

Proudly distributed by:



16 Parkinson Lane
O'Connor WA 6163
Australia

Phone +61 8 9331 3100
Fax +61 8 9331 5150
Email mail@amelec.com.au
Web www.amelec.com.au